

# *MINI KINTA™ IRC*

## User Manual

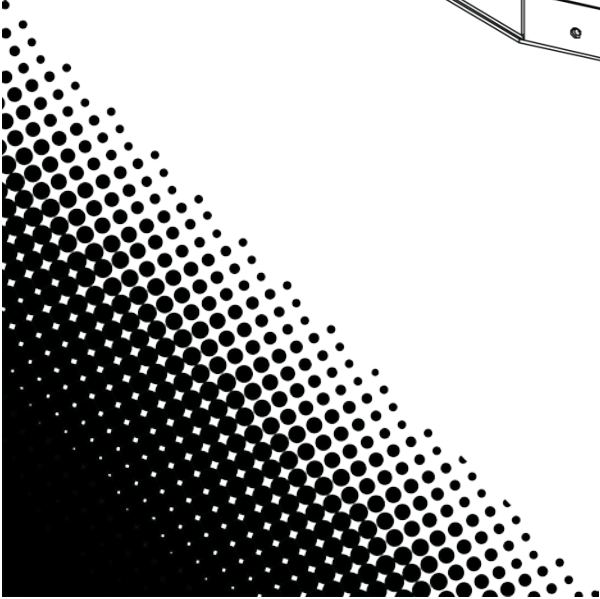
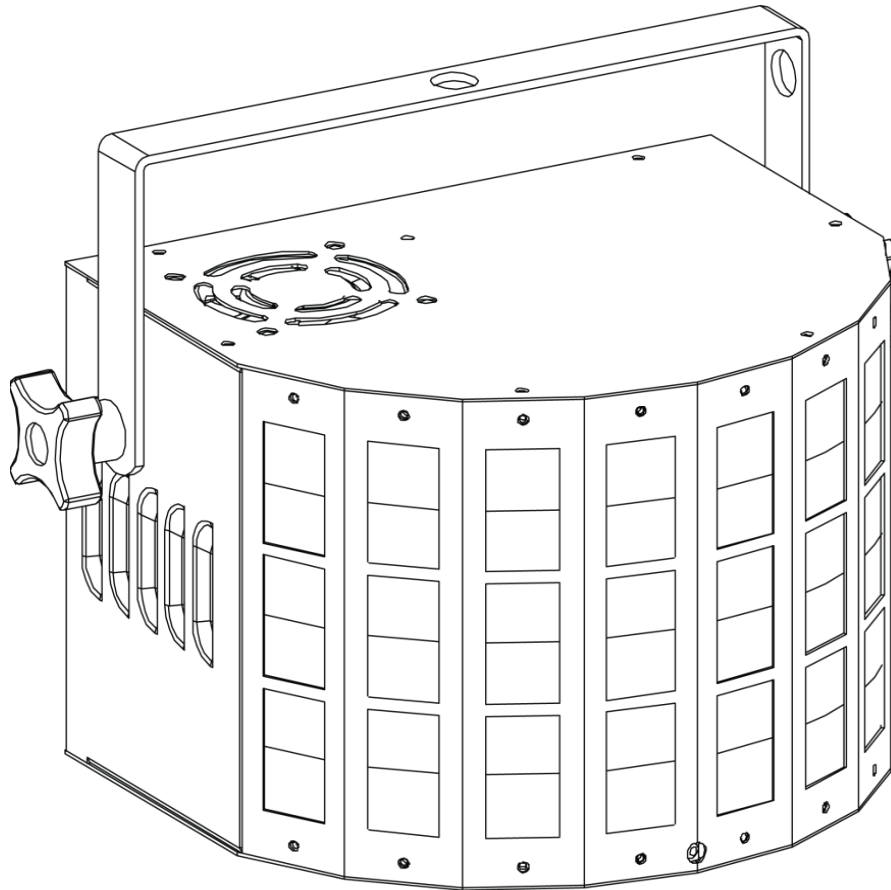

---

# TABLE OF CONTENTS

<b>1. Before You Begin</b> .....	<b>3</b>
What Is Included .....	3
Unpacking Instructions .....	3
Claims.....	3
Text Conventions .....	3
Symbols .....	3
Disclaimer .....	3
Product at a Glance .....	4
Safety Notes.....	4
<b>2. Introduction</b> .....	<b>5</b>
Product Overview .....	5
Product Dimensions .....	6
<b>3. Setup</b> .....	<b>7</b>
AC Power .....	7
Fuse Replacement .....	7
Power Linking .....	7
Mounting .....	8
Orientation .....	8
Rigging .....	8
<b>4. Operation</b> .....	<b>9</b>
Control Panel Operation.....	9
Menu Map .....	9
DMX Linking.....	9
Configuration (DMX) .....	9
Starting Address .....	9
DMX Channel Assignments and Values .....	10
4CH .....	10
Configuration (Standalone) .....	10
Automatic Mode (including Sound-Active Mode) .....	10
Color Control and Strobe .....	11
Display Orientation .....	11
Display Time-Out.....	11
Software Version .....	11
IRC-6 Infrared Remote Control .....	12
IRC-6 Operation.....	12
Linking IRC Control With the Mini Kinta™ .....	12
Master/Slave Mode.....	13
<b>5. Maintenance</b> .....	<b>14</b>
Product Maintenance .....	14
<b>6. Technical Specifications</b> .....	<b>15</b>
Returns.....	16
<b>Contact Us</b> .....	<b>17</b>

# 1. BEFORE YOU BEGIN

## What Is Included

- Mini Kinta™ IRC
- Power Cord
- Warranty Card
- Quick Reference Guide

## Unpacking Instructions

Carefully unpack the product immediately and check the container to make sure all the parts are in the package and are in good condition.

## Claims



If the box or the contents (the product and included accessories) appear damaged from shipping, or show signs of mishandling, notify the carrier immediately, not Chauvet. Failure to report damage to the carrier immediately may invalidate your claim. In addition, keep the box and contents for inspection.

For other issues, such as missing components or parts, damage not related to shipping, or concealed damage, file a claim with Chauvet within 7 days of delivery.

## Text Conventions

Convention	Meaning
1—512	A range of values
50/60	A set of values of which only one can be chosen
Settings	A menu option not to be modified
Menu > Settings	A sequence of menu options to be followed
<ENTER>	A key to be pressed on the product's control panel
ON	A value to be entered or selected

## Symbols

Symbol	Meaning
	Critical installation, configuration, or operation information. Not following these instructions may make the product not work, cause damage to the product, or cause harm to the operator.
	Important installation or configuration information. The product may not function correctly if this information is not used.
	Useful information.

## Disclaimer

The information and specifications contained in this document are subject to change without notice. Chauvet assumes no responsibility or liability for any errors or omissions that may appear in this manual. Chauvet reserves the right to update the existing document or to create a new document to correct any errors or omissions.

You can download the latest version of this document from [www.chauvetlighting.com](http://www.chauvetlighting.com).

© Copyright 2015 Chauvet. All rights reserved.

Electronically published by Chauvet in the United States of America.

Author	Date	Editor	Updated
A. Leon	04/02/15	R.Isenstadt	04/02/15

## Product at a Glance

Use on Dimmer	X	Auto Programs	P
Outdoor Use	X	Auto-ranging Power Supply	P
Sound-Active	P	Replaceable Fuse	P
DMX	P	User-Serviceable	X
Master/Slave	P		

## Safety Notes

Please read the following Safety Notes carefully before working with the product. The Notes include important safety information about installation, usage, and maintenance.



- Always connect the product to a grounded circuit to avoid the risk of electrocution.
- Always disconnect the product from the power source before cleaning or replacing the fuse.
- Avoid direct eye exposure to the light source while the product is on.
- Make sure the power cord is not crimped or damaged.
- Never disconnect the product from power cord by pulling or tugging on the cord.
- If mounting the product overhead, always secure to a fastening device using a safety cable.
- Make sure there are no flammable materials close to the product when operating.
- Do not touch the product's housing when operating because it may be very hot.



- The product is not intended for permanent installation.
- Always make sure that the voltage of the outlet to which you are connecting the product is within the range stated on the decal or rear panel of the product.
- The product is for indoor use only! (IP20) To prevent risk of fire or shock, do not expose the product to rain or moisture.
- Always install the product in a location with adequate ventilation, at least 20 in (50 cm) from adjacent surfaces.
- Be sure that no ventilation slots on the product's housing are blocked.
- Never connect the product to a dimmer.
- Make sure to replace the fuse with another of the same type and rating.
- Never carry the product from the power cord or any moving part. Always use the hanging/mounting bracket.
- The maximum ambient temperature (Ta) is 104 °F (40 °C). Do not operate the product at higher temperatures.
- In the event of a serious operating problem, stop using the product immediately.
- Never try to repair the product. Repairs carried out by unskilled people can lead to damage or malfunction. Please contact the nearest authorized technical assistance center.
- To eliminate unnecessary wear and improve its lifespan, during periods of non-use completely disconnect the product from power via breaker or by unplugging it.



Keep this User Manual for future use. If you sell the product to someone else, be sure that they also receive this document.

## 2. INTRODUCTION

### Product Overview

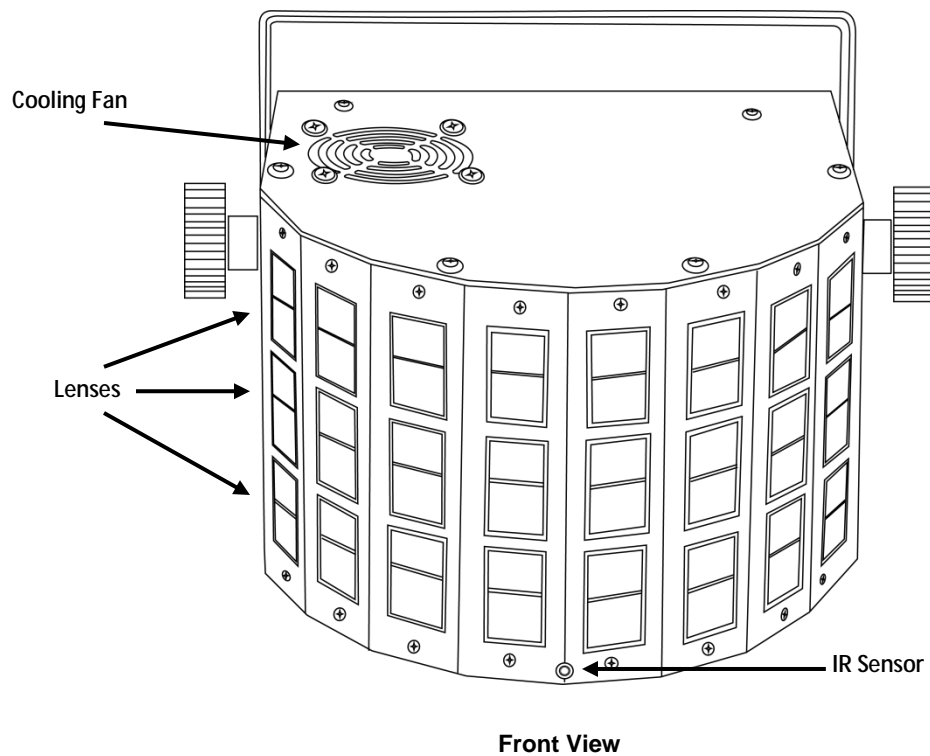
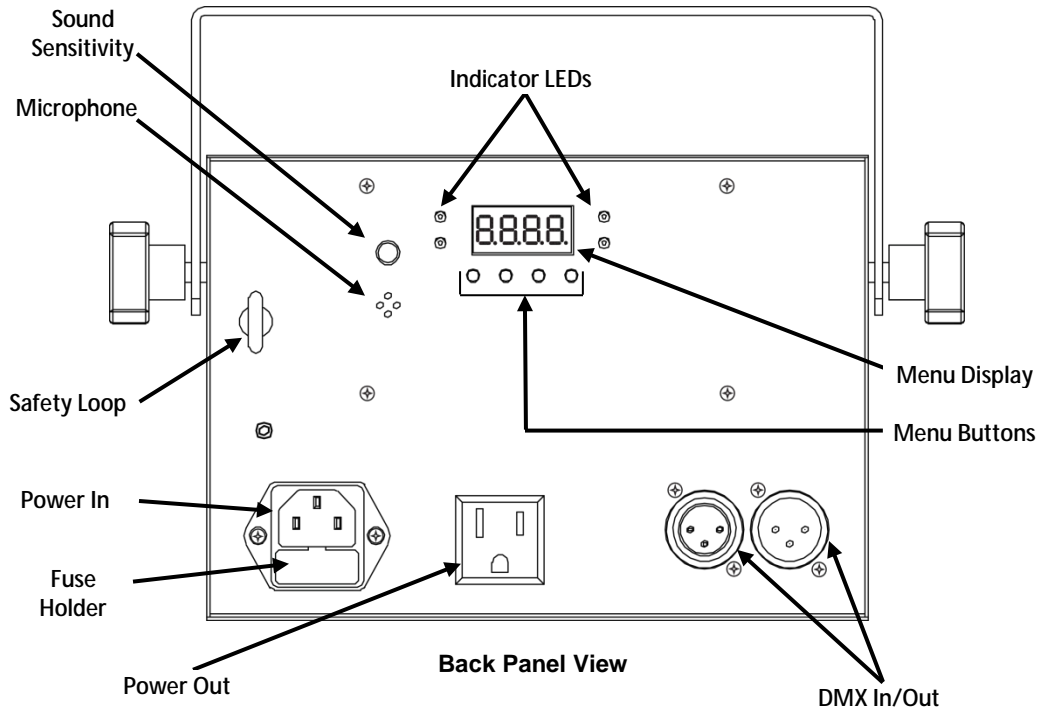

# Product Dimensions

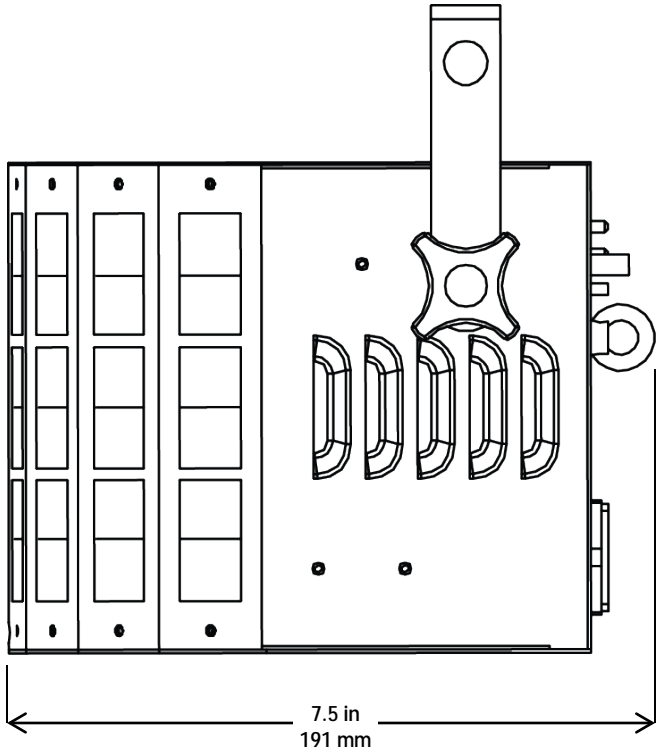
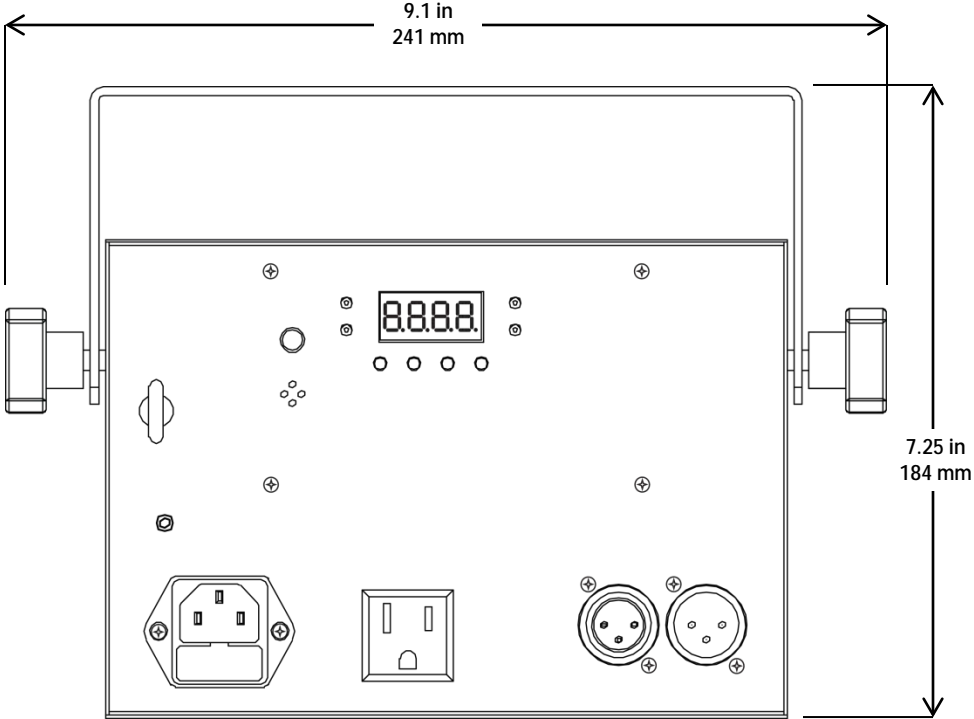

### 3. SETUP

#### AC Power

The Mini Kinta™ IRC has an auto-ranging power supply and it can work with an input voltage range of 100 to 240 VAC, 50/60 Hz. To determine the product's power requirements (circuit breaker, power outlet, and wiring), use the current value listed on the label affixed to the product's back panel, or refer to the product's specifications chart. The listed current rating indicates the product's average current draw under normal conditions.



**Always connect the product to a protected circuit (circuit breaker or fuse). Make sure the product has an appropriate electrical ground to avoid the risk of electrocution or fire.**



**Never connect the product to a rheostat (variable resistor) or dimmer circuit, even if the rheostat or dimmer channel serves only as a 0 to 100% switch.**

#### Fuse Replacement

1. Wedge the tip of a flat-head screwdriver into the slot of the fuse holder.
2. Pry the fuse holder out of the housing.
3. Remove the blown fuse from the holder and replace with a fuse of the exact same type and rating.
4. Insert the fuse holder back in place and reconnect power.

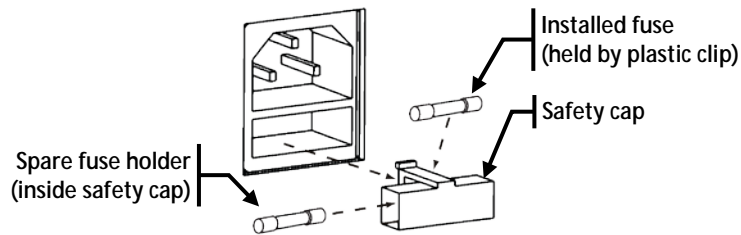

**Disconnect the product from the power outlet before replacing the fuse.**

#### Power Linking

The product provides power linking via the Edison outlet located in the back of the unit. Please see the diagram below for further explanation.

#### Power Linking Diagram

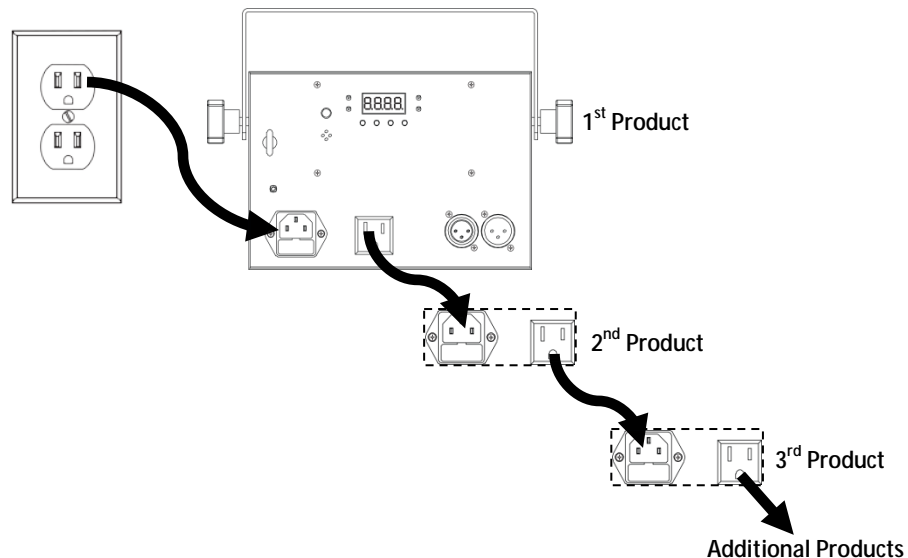

**You can power link up to 29 Mini Kinta™ IRC units on 120 VAC or up to 53 Mini Kinta™ IRC units on 230 VAC.**



**The power linking diagram corresponds to the North American version of the product ONLY! If using the product in other markets, you must consult with the local Chauvet distributor as power linking connectors and requirements may differ in your country or region.**

**Mounting** Before mounting the product, read and follow the safety recommendations indicated in the [Safety Notes](#).

**Orientation** The Mini Kinta™ IRC may be mounted in any position; however, make sure adequate ventilation is provided around the product.

- Rigging**
- Before deciding on a location for the product, always make sure there is easy access to the product for maintenance and programming purposes.
  - Make sure that the structure onto which you are mounting the product can support the product's weight. See the [Technical Specifications](#) for weight information.
  - When mounting the product overhead, always use a safety cable. Mount the product securely to a rigging point, whether an elevated platform or a truss.
  - When rigging the product onto a truss, use a mounting clamp of appropriate weight capacity.
  - When power linking multiple products, mount the products close enough for power linking cables to reach.
  - The bracket adjustment knobs allow for directional adjustment when aiming the product to the desired angle. Only loosen or tighten the bracket knobs manually. Using tools could damage the knobs.

**Mounting Diagram**

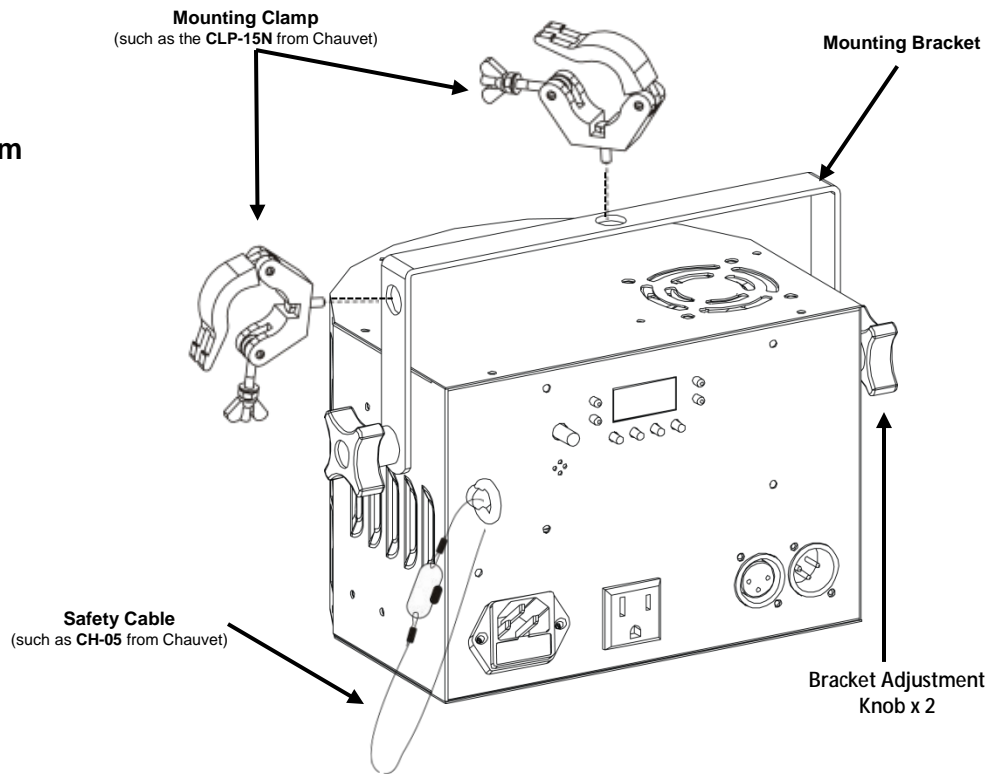



## 4. OPERATION

**Control Panel Operation** To access the control panel functions, use the four buttons located underneath the display. Please refer to the [Product Overview](#) to see the button locations on the control panel.

Button	Function
<MENU>	Press to find an operation mode or to back out of the current menu option
<UP>	Press to scroll up the list of options or to find a higher value
<DOWN>	Press to scroll down the list of options or to find a lower value
<ENTER>	Press to activate a menu option or a selected value

### Menu Map

Mode	Programming Steps		Description
DMX Mode	Addr	A001–A509	Selects the DMX starting address
Slave Mode	SLnd	SL-1	Sets slave mode
Auto/Sound Modes	Auto	Aut	Sets Auto/Sound mode
Color Control and Strobe	CoLo	r000–r255	Adjusts red value 0–100%
		G000–G255	Adjusts green value 0–100%
		b000–b255	Adjusts blue value 0–100%
		U000–U255	Adjusts white value 0–100%
		Str1	Selects Strobe 1 (slow)
		Str2	Selects Strobe 2 (medium)
Display Time-out	LEd	on	Sets Display to turn off after inactivity
		oFF	Sets Display to stay on at all times
		dISP	Normalizes Display
Display Orientation	dISP	dSIP	Inverts Display
		XX.XX	Displays the software version

**DMX Linking** The Mini Kinta™ IRC works with a DMX controller. Information about DMX is in the CHAUVET® DMX Primer, which is available from the Chauvet website [http://www.chauvetlighting.com/downloads/DMX\\_Primer\\_rev05\\_WO.pdf](http://www.chauvetlighting.com/downloads/DMX_Primer_rev05_WO.pdf).

**Configuration (DMX)** Set the product in DMX mode to control with a DMX controller.

1. Connect the product to a suitable power outlet.
2. Connect a DMX cable from the DMX output of the DMX controller to the DMX input socket on the product.

**Starting Address** When selecting a starting DMX address, always consider the number of DMX channels the selected DMX mode uses. If you choose a starting address that is too high, you could restrict the access to some of the product's channels.

The Mini Kinta™ IRC uses up to 4 DMX channels in a 4-CH DMX mode, which defines the highest configurable address to **509**.

If you are not familiar with the DMX protocol, download the DMX Primer from [www.chauvetlighting.com](http://www.chauvetlighting.com).

To select the starting address, do the following:

1. Press <MENU> repeatedly until **Addr** shows on the display.
2. Press <ENTER> and **A001–A509** will show on the display.
3. Use <UP> or <DOWN> to select the starting address.
4. Press <ENTER>.

## DMX Channel Assignments and Values

4CH	Channel	Function	Value	Percent/Setting
1		<b>Control/ Operating Mode</b>	000◊ 005	No function
			006◊ 020	Red
			021◊ 035	Green
			036◊ 050	Blue
			051◊ 065	White
			066◊ 080	Red/Green
			081◊ 095	Red/Blue
			096◊ 110	Red/White
			111◊ 125	Green/Blue
			126◊ 140	Green/White
			141◊ 155	Blue/White
			156◊ 170	Red/Green/Blue
			171◊ 185	Red/Green/White
			186◊ 200	Green/Blue/White
			201◊ 215	Red/Green/Blue/White
2		<b>Strobe</b>	000◊ 005	No strobe
			006◊ 255	Strobe (slow to fast)
3		<b>Motor Rotation</b>	000◊ 127	Motor indexing
			128◊ 255	Motor speed
4		<b>Auto/Sound Mode</b>	000◊ 004	No function
			005◊ 200	Auto mode (slow to fast)
			201◊ 255	Sound mode

**Configuration (Standalone)** Set the product in one of the standalone modes to control without a DMX controller.

- Connect the product to a suitable power outlet.



**Never connect a product that is operating in any standalone mode to a DMX string connected to a DMX controller. Products in standalone mode may transmit DMX signals that could interfere with the DMX signals from the controller.**

### Automatic Mode (including Sound-Active Mode)

To run the Mini Kinta™ IRC in automatic mode, follow the instructions below:

1. Press <MENU> repeatedly until **Auto** shows on the display.
2. Press <ENTER> and **Aut** will show on the display.
3. Turn the music on and adjust the sound sensitivity knob until the product responds to the beat of the music.



**The product will only respond to low frequencies of music (bass and drums).**

---

**Color Control and Strobe** To custom mix a color and select the strobe speed, follow the instructions below:

1. Press **<MENU>** repeatedly until **CoLo** shows on the display.
2. Press **<ENTER>** and one of the following will show on the display:
  - **rxxx** (red, 000-255)
  - **Gxxx** (green, 000-255)
  - **bxxx** (blue, 000-255)
  - **Uxxx** (white, 000-255)
  - **Str1** (slow strobe)
  - **Str2** (medium strobe)
  - **Str3** (fast strobe)
3. Press **<ENTER>** to cycle through the color and strobe speed settings.
4. With the color options, when the desired color shows on the display, use **<UP>** or **<DOWN>** to select the desired color value.  
**NOTE:** Selecting **0** will turn the color off.
5. Repeat steps 3 and 4 until you have your desired color.
6. To select strobe speed, press **<ENTER>** until the desired strobe setting shows on the display.  
**NOTE:** For no strobe effect, press **<ENTER>** until a color option shows on the display.

**Display Orientation** To set the orientation of the display, follow the instructions below:

1. Press **<MENU>** repeatedly until **diSP** shows on the display.
2. Press **<ENTER>**.
3. Use **<UP>** or **<DOWN>** to select either:
  - **diSP** for normal mode.
  - **dSiP** for inverted mode.
4. Press **<ENTER>**.

**Display Time-Out** To set the display to turn off after inactivity or not, do the following:

1. Press **<MENU>** repeatedly until **LEd** shows on the display.
2. Press **<ENTER>**.
3. Use **<UP>** or **<DOWN>** to select either:
  - **on** to set the display to turn off after inactivity.
  - **oFF** to set the display to stay on at all times.
4. Press **<ENTER>**.

**Software Version** To view the software version, do the following:

1. Press **<MENU>** repeatedly until **uEr** shows on the display.
2. Press **<ENTER>**.

## IRC-6 Infrared Remote Control

The Mini Kinta™ IRC is compatible with the IRC-6 infrared remote control from Chauvet. IRC mode will activate at the press of any button on the remote, as long as the product is not in slave mode. After activating IRC mode, **rEN** will show on the display.

### IRC-6 Operation

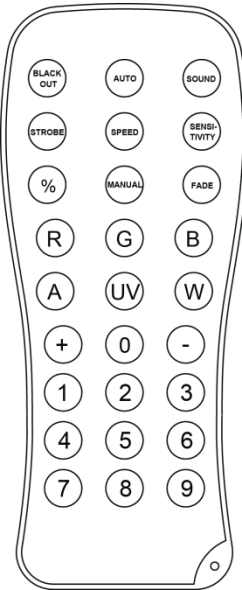

Be sure the IRC-6 remote is pointing directly at the product and there is nothing in between the remote and the product.

The following buttons function with this product:

- **<MANUAL>** - Activates manual color mode
- **<R>** - Turns red on/off
- **<G>** - Turns green on/off
- **<B>** - Turns blue on/off
- **<W>** - Turns white on/off
- **<SOUND>** - Activates Sound mode
- **<STROBE>** - Activates strobe
- **<AUTO>** - Activates auto programs (<0> through <9>)

<b>&lt;0&gt;</b> - Red/Green/Blue/White	<b>&lt;5&gt;</b> - Green/Blue
<b>&lt;1&gt;</b> - Red	<b>&lt;6&gt;</b> - Blue
<b>&lt;2&gt;</b> - Red/White	<b>&lt;7&gt;</b> - Red/Blue
<b>&lt;3&gt;</b> - Red/Green	<b>&lt;8&gt;</b> - Green/White
<b>&lt;4&gt;</b> - Green	<b>&lt;9&gt;</b> - Blue/White

- **<SPEED>** - Activates speed control in Auto mode  
**NOTE:** For strobe speed, do not press the speed button
- **<+>** - Increases auto program or strobe speed
- **<->** - Decreases auto program or strobe speed
- **<BLACK OUT>** - Turns LEDs on/off
- All other buttons on the remote have no function with this product.

**The IRC-6 will not respond to any inputs when Black Out is activated. If the remote does not respond when a button is pressed, try pressing <BLACK OUT>. You may have inadvertently activated Black Out.**

### Linking IRC Control With the Mini Kinta™

It is possible to control the original Mini Kinta™ or several Mini Kinta™ units with the IRC-6, by slaving them to a Mini Kinta™ IRC. Follow the instructions under [Master/Slave Mode](#) for more information on Master/Slave mode.

**Note:** The master must be a Mini Kinta™ IRC to run any Mini Kinta™ products with the IRC-6.

---

## Master/Slave Mode

The Master/Slave mode allows a single Mini Kinta™ IRC (the master) to control the actions of one or more Mini Kinta™ or Mini Kinta™ IRC products (the slaves) without the need of a DMX controller. The master will be set to operate in either Auto/Sound mode or a custom mix, while the slave units will be set to operate in Slave mode. Once set and connected, the slaves will operate in unison with the master.

Configure the units as indicated below.

### Slaves:

1. Press **<MENU>** repeatedly until **SLnd** shows on the display.
2. Press **<ENTER>** and **SL-1** will show on the display.
3. Connect the DMX input of the first slave unit to the DMX output of the master.
4. Connect the DMX input of the subsequent slaves to the DMX output of the previous slave.
5. Finish setting and connecting all the slaves.

### Master:

1. Set the master to operate in a custom mix or Auto/Sound mode through the menu or with the IRC-6.
2. Make the master the first unit in the daisy chain.



- **Configure all the slaves before connecting the master to the daisy chain.**
- **Never connect a DMX controller to a DMX string configured for Master/Slave operation because the controller may interfere with the signals from the master.**
- **Do not connect more than 10 slaves to the master.**

---

## 5. MAINTENANCE

### **Product Maintenance**

Dust build-up reduces light output performance and can cause overheating. This can lead to reduction of the light source's life and/or mechanical wear. To maintain optimum performance and minimize wear, clean your lighting products at least twice a month. However, be aware that usage and environmental conditions could be contributing factors to increase the cleaning frequency.

To clean the product, follow the instructions below:

1. Unplug the product from power.
2. Wait until the product is at room temperature.
3. Use a vacuum (or dry compressed air) and a soft brush to remove dust collected on the external surface/vents.
4. Clean all transparent surfaces with a mild soap solution, ammonia-free glass cleaner, or isopropyl alcohol.
5. Apply the solution directly to a soft, lint free cotton cloth or a lens cleaning tissue.
6. Softly drag any dirt or grime to the outside of the transparent surface.
7. Gently polish the transparent surfaces until they are free of haze and lint.



**Always dry the transparent surfaces carefully after cleaning them.**



**Do not spin the cooling fans using compressed air because you could damage them.**

## 6. TECHNICAL SPECIFICATIONS

<b>Dimensions and Weight</b>	<b>Length</b>	<b>Width</b>	<b>Height</b>	<b>Weight</b>
	7.5 in (191 mm)	9.1 in (241 mm)	7.25 in (184 mm)	3.4 lb (1.6 kg)
<b>Note:</b> Dimensions in inches rounded to the nearest decimal digit.				
<b>Power</b>	<b>Power Supply Type</b>	<b>Range</b>	<b>Voltage Selection</b>	
	Switching (internal)	100 to 240 VAC, 50/60 Hz	Auto-ranging	
	<b>Parameter</b>	<b>120 V, 60 Hz</b>	<b>230 V, 50 Hz</b>	
	Consumption	19 W	18 W	
	Operating Current	0.3 A	0.2 A	
<b>Power I/O</b>	<b>Power I/O</b>	<b>U.S./Worldwide</b>	<b>UK/Europe</b>	
	Power input connector	IEC	IEC	
	Power output connector	Edison	IEC	
	Power Cord plug	Edison (U.S.)	Local plug	
<b>Light Source</b>	<b>Type</b>	<b>Power</b>	<b>Lifespan</b>	
	LED	3 W	50,000 hours	
	<b>Color</b>	<b>Quantity</b>	<b>Current</b>	
	Red	1	0.24 A	
	Green	1	0.24 A	
<b>Photometrics</b>	<b>Parameter</b>			
	Coverage angle	114°		
	<b>Maximum External Temp.</b>	<b>Cooling System</b>		
<b>Thermal</b>	104 °F (40 °C)	Fan-assisted Convection		
	<b>I/O Connectors</b>	<b>Channel Range</b>		
<b>DMX</b>	3-pin XLR	4		
	<b>Product Name</b>	<b>Item Code</b>	<b>UPC Number</b>	
<b>Ordering</b>	Mini Kinta™ IRC	10050950	781462212988	

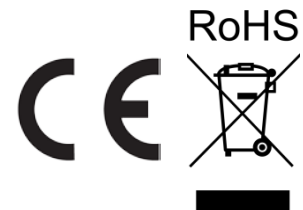

---

## Returns

To return a product or request support:

- In the U.S., contact Chauvet World Headquarters (See [Contact Us](#)).
- In the UK or Ireland, contact Chauvet Europe Ltd. (See [Contact Us](#)).
- In Mexico, contact Chauvet Mexico. (See [Contact Us](#)).
- In Benelux, contact Chauvet Europe BVBA. (See [Contact Us](#)).
- In any other country, DO NOT contact Chauvet. Instead, contact your lighting distributor. See [www.chauvetlighting.com](http://www.chauvetlighting.com) for distributors outside the U.S., UK, Ireland, Mexico, or Benelux.



**Outside the U.S., UK, Ireland, Mexico, or Benelux, contact your distributor and follow their instructions on how to return Chauvet products to them. Visit our website for contact details.**

Call the corresponding Chauvet Technical Support office and request a Return Merchandise Authorization (RMA) number before shipping the product. Be prepared to provide the model number, serial number, and a brief description of the cause for the return.

You must send the merchandise prepaid, in its original box, and with its original packing and accessories. Chauvet will not issue call tags.

Clearly label the package with the RMA number. Chauvet will refuse any product returned without an RMA number.



**Write the RMA number on a properly affixed label. DO NOT write the RMA number directly on the box.**

Before sending the product, clearly write the following information on a piece of paper and place it inside the box:

- Your name
- Your address
- Your phone number
- RMA number
- A brief description of the problem

Be sure to pack the product properly. Any shipping damage resulting from inadequate packaging will be your responsibility. FedEx packing or double-boxing are recommended.



**Chauvet reserves the right to use its own discretion to repair or replace returned product(s).**



---

# CONTACT Us

## **WORLD HEADQUARTERS** - Chauvet

### **General Information**

Address: 5200 NW 108th Avenue  
Sunrise, FL 33351

Voice: (954) 577-4455

Fax: (954) 929-5560

Toll free: (800) 762-1084

### **Technical Support**

Voice: (954) 577-4455 (Press 4)

Fax: (954) 756-8015

Email: [tech@chauvetlighting.com](mailto:tech@chauvetlighting.com)

### **World Wide Web**

[www.chauvetlighting.com](http://www.chauvetlighting.com)

## **UNITED KINGDOM AND IRELAND** - Chauvet Europe Ltd.

### **General Information**

Address: Unit 1C  
Brookhill Road Industrial

Estate

Pinxton, Nottingham, UK  
NG16 6NT

Voice: +44 (0)1773 511115

Fax: +44 (0)1773 511110

### **Technical Support**

Email:

[uktech@chauvetlighting.com](mailto:uktech@chauvetlighting.com)

### **World Wide Web**

[www.chauvetlighting.co.uk](http://www.chauvetlighting.co.uk)

## **MEXICO** - Chauvet Mexico

### **General Information**

Address: Av. Santa Ana 30  
Parque Industrial Lerma  
Lerma, Mexico C.P. 52000

Voice: +52 (728) 285-5000

### **Technical Support**

Email: [servicio@chauvet.com.mx](mailto:servicio@chauvet.com.mx)

### **World Wide Web**

[www.chauvet.com.mx](http://www.chauvet.com.mx)

## **CHAUVET EUROPE** - Chauvet Europe BVBA

### **General Information**

Address: Stokstraat 18  
9770 Kruishoutem  
Belgium

Voice: +32 9 388 93 97

### **Technical Support**

Email: [Eutech@chauvetlighting.eu](mailto:Eutech@chauvetlighting.eu)

### **World Wide Web**

[www.chauvetlighting.eu](http://www.chauvetlighting.eu)

Outside the U.S., United Kingdom, Ireland, Mexico, or Benelux, contact your dealer. Follow their instructions to request support or to return a product. Visit our website for contact details.